

SS1CH-AVI Series

Stainless Steel Weatherproof Fixed Camera Housing

Integrated with Avigilon Camera Module



SS1CH

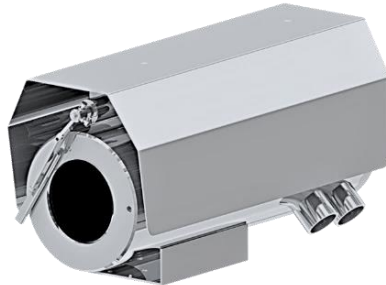

SS1CH-W



SS1CH-LEDW

Main Features



Marine grade
AISI316L Stainless
Steel material



Option for IEEE
802.3at PoE+



IP 66 / 68



Vandal-proof IK10
ratings



True Wide Dynamic
Range



Next-Generation
Video Analytics



Multiple lens options
available



Options for LED
illuminator available

Technical Data

General	
Ingress Protection	IP 66 / 68
Operating Temperature	-40°C to 60°C
Relative Humidity	≤95%
Mechanical	
Body Material	AISI316L Stainless Steel
Sight Glass Material	Window with hardened mineral clear tempered glass
	Window with Germanium glass (for SS1CH-G and SS1CH-GL models)
Overall Dimension (WxHxD)	<i>Please refer to overall dimension drawings of each model.</i>
Internal Usable Size for Camera Module	Ø80 x 155 mm
Cable Entry	2 x M25
Weight	Approximate 20KG
Electrical	
Operating Voltage	AC110-240V (0.5A - 1.10A), 50/60Hz Optional: IEEE 802.3at PoE+
Power Consumption	Max 110W (110V), Max 120W (240V)
Thermostatically Controlled Heater	T°C on: <10°C, T°C off: >10°C
Optional	
Wiper Mechanism	Available for SS1CH-W and SS1CH-LEDW model
LED Illumination	Up to 200 meters (Available for SS1CH-LED and SS1CH-LEDW model)
Accessories	
Standard	Sunshield, Swivel Joints
Optional	Wall Bracket

	Self-learning Video Analytics Range					
	2MP, 18x Zoom	2MP	4MP (9)	4MP (22)	6MP	8MP [4K]
Sensor	1/2.8"				1/1.8"	
Focal Length (mm)	4.7 - 84.6	3.3 - 9	3.3 - 9	9 - 22	4.9 - 8	4.9 - 8
Focus	F1.6	F1.3	F1.3	F1.6	F1.8	
Effective Pixels (HxV)	(16:9) 1920 x 1080		(16:9) 2560 x 1440 (4:3) 2304 x 1728		(16:9) 3200 x 1800 (3:2) 3027 x 2048	(16:9) 3840 x 2160
Horizontal Angle of View	(16:9) 4.1° - 60°	(16:9) 34° - 99°	(16:9) (4:3) 34° - 92°	(16:9) 14° - 31° (4:3) 11° - 24°	(16:9) 52° - 92° (3:2) 41° - 73°	(16:9) 52° - 92°
Max Image Rate	(50 Hz/60 Hz): 25 fps/30 fps		WDR off (50 Hz/60 Hz): 25 fps/30 fps WDR on (50 Hz/60 Hz): 20 fps/20 fps		(50 Hz/60 Hz): 25 fps/30 fps	
Day/Night Control	Automatic, Manual					
Illumination Requirement	Color: 0.039Lux B/W: 0.02Lux	Color: 0.027Lux B/W: 0.014Lux	Color: 0.03Lux B/W: 0.015Lux	Color: 0.058Lux B/W: 0.029Lux	Color: 0.055Lux B/W: 0.028Lux	
Image Compression Method	H.264 HDSM SmartCodec, H.265 HDSM SmartCodec, Motion JPEG					
Protocols	IPv6, IPv4, HTTP, HTTPS, SOAP, DNS, NTP, RTSP, RTCP, RTP, TCP, UDP, IGMP, ICMP, DHCP, Zeroconf, ARP					
Supported Video Analytics Events	Objects in Area, Loitering, Crossing Beam, Object Appears or Enters Area, Object Not Present in Area, Objects Enter Area, Objects Leave Area, Object Stops in Area, Direction Violated, Tamper Detection					

*Analog camera and other camera module options are available upon request.

*Thermal camera options are available for G model. Please contact us for the details

Outline Dimensions (mm)

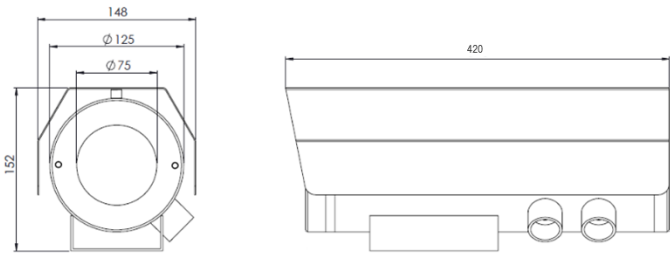

SS1CH Outline Dimensions

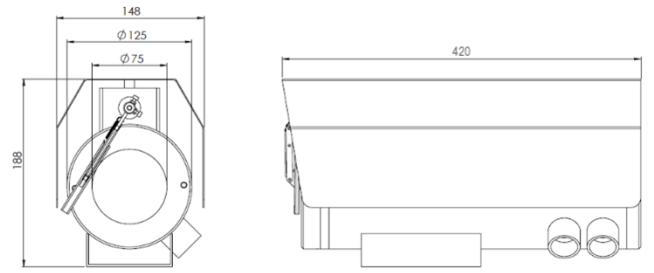

SS1CH-W Outline Dimensions

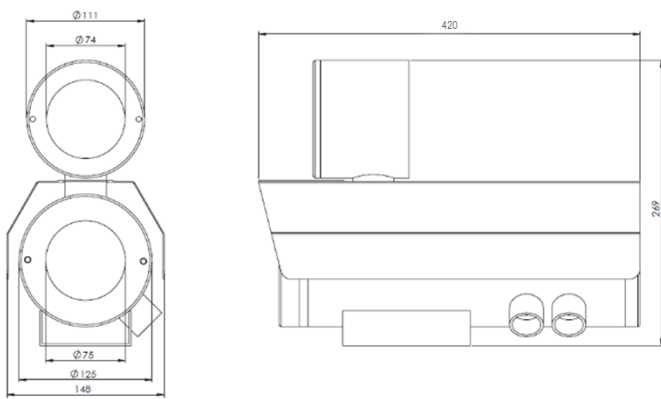

SS1CH-LED Outline Dimensions

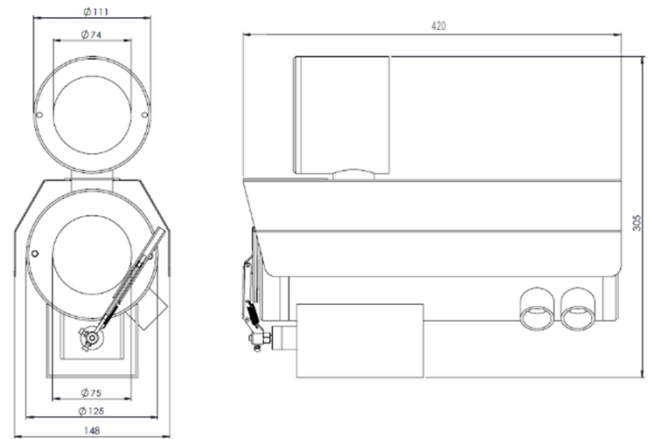

SS1CH-LEDW Outline Dimensions

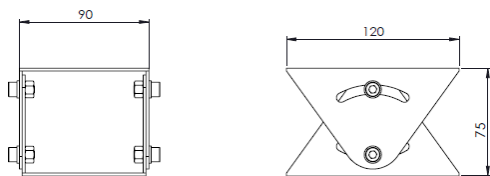

SJ-SS1CH - Swivel Joints Outline Dimensions

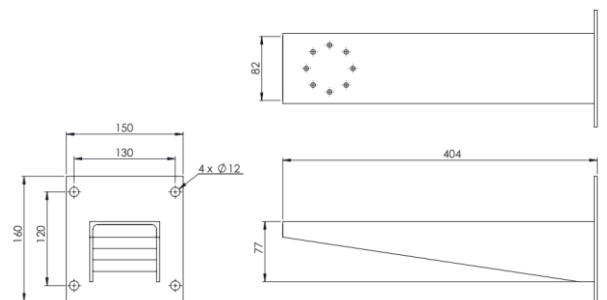

WB-SS1CH - Wall Bracket Outline Dimensions

Model & Ordering Code

SS1CH - X - AVI - X - X

POE Options

Blank : No additional option
POE : POE+

Camera Module Options

18x2M : 2MP, 18x Zoom, IP with Self-learning Video Analytics
2M : 2MP, IP with Self-learning Video Analytics
4M (9) : 4MP (3.3-9mm), IP with Self-learning Video Analytics
4M (22) : 4MP (9-22mm), IP with Self-learning Video Analytics
6M : 6MP, IP with Self-learning Video Analytics
8M : 8MP, IP with Self-learning Video Analytics

Additional Options

Blank : No additional option
W : Fitted with wiper mechanism
LED : With LED Illuminator
LEDW : With LED Illuminator and Wiper

Standard Accessories

SCH-SS1CH : Sunshield for Camera Housing (for SS1 series without LED illuminator)
SCH-SS1CH-LED : Sunshield for Camera Housing with LED illuminator (for SS1CH-LED and SS1CH-LEDW)
SJ-SS1CH : Swivel Joints

Optional Accessories

WB-SS1CH : Wall Bracket