

## SX1CH Series

### Explosion Proof Fixed Camera Housing



SX1CH



SX1CH-W



SX1CH-LEDW



SX1CH-G

### Main Features



Marine grade  
AISI316L Stainless  
Steel material



Ex II 2 G Ex db op pr IIC T6 Gb  
/ Ex II 2 D Ex tb op pr IIIC  
T80°C Db



IP 66 / 68



Vandal-proof IK10  
ratings



Operating  
Temperature -40°C to  
60°C



Possible to integrate  
with different type of  
3rd party camera  
module



Options for thermal  
camera available



Options for LED  
illuminator available

## Technical Data

General	
Certification	Ex II 2 G Ex db op pr IIC T6 Gb / Ex II 2 D Ex tb op pr IIIC T80°C Db
Ingress Protection	IP 66 / 68
Operating Temperature	-40°C to 60°C
Relative Humidity	≤95%
Mechanical	
Body Material	AISI316L Stainless Steel
Sight Glass Material	Window with hardened mineral clear tempered glass
	Window with Germanium glass (for SX1CH-G and SX1CH-GL models)
Overall Dimension (WxHxD)	<i>Please refer to overall dimension drawings of each model.</i>
Internal Usable Size for Camera Module	Ø105 x 250 mm
Cable Entry	2 x M25
Weight	Approximate 25KG
Electrical	
Operating Voltage	AC110-240V (0.5A - 1.10A), 50/60Hz
Power Consumption	Max 110W (110V), Max 120W (240V)
Thermostatically Controlled Heater	T°C on: <10°C, T°C off: >10°C
Optional	
Wiper Mechanism	Available for SX1CH-W and SX1CH-LEDW model
LED Illumination	Up to 200 meters (Available for SX1CH-LED and SX1CH-LEDW model)
Built in Fiber Optic Module	Single Mode or Multi Mode (-SM or -MM model, please refer to below ordering info)
Accessories	
Standard	Sunshield, Swivel Joints
Optional	Wall Bracket

## IP Camera/Lens

	4K, 22x Zoom, IP	3MP, 33x Zoom, IP	5MP, 5x Zoom, IP	8MP, 5x Zoom, IP	Self-learning Video Analytics Range					
					2MP, 18x Zoom, IP	2MP, IP	4MP (9), IP	4MP (22), IP	6MP, IP	8MP, IP
Sensor	1/1.8"	1/2.8"	1/2.8"	1/2.8"	1/2.8"				1/1.8"	
Focal Length (mm)	6.4 - 138.5	4.6 - 152.0	2.7 - 13.5	2.7 - 13.5	4.7 - 84.6	3.3 - 9	3.3 - 9	9 - 22	4.9 - 8	4.9 - 8
Focus	F1.5	F1.6	F1.6	F1.6	F1.6	F1.3	F1.3	F1.6	F1.8	
Horizontal Angle of View	3° - 64°	3° - 52°	103.4° - 23.8°	102.7°~29°	4.1° - 60°	34° - 99°	34° - 92°	14° - 31°	52° - 92°	52° - 92°
Effective Pixels (HxV)	3864 x 2180	2065 x 1553	2592 x 1944	3840x2160	1920 x 1080		2560 x 1440		3200 x 1800	3840 x 2160
Day/Night	Automatic removable IR-cut filter		Dual IR Cut Filter with Auto Switch	Dual IR Cut Filter with Auto Switch	Automatic, Manual					
Illumination Requirement	Color: 0.04Lux B/W: 0.002Lux		Color: 0.001Lux B/W: 0Lux with IR	Color: 0.01Lux@ (F1.6, ACG ON), B/W: 0Lux with IR	Color: 0.039Lux B/W: 0.02Lux	Color: 0.027Lux B/W: 0.014Lux	Color: 0.03Lux B/W: 0.015Lux	Color: 0.058Lux B/W: 0.029Lux	Color: 0.055Lux B/W: 0.028Lux	
Supported Video Analytics Events	Motion Detection, Tampering		Tripwire, Double Tripwire, Perimeter, Object Abandon, Object Lost, Loitering, Running, Parking, Crowded, People Counting, On Duty Detection, Video Abnormal, Audio Abnormal, Heatmap, Face Capture (Face Detection), Safety Helmet Detection, Human/Vehicle Classification		Objects in Area, Loitering, Crossing Beam, Object Appears or Enters Area, Object Not Present in Area, Objects Enter Area, Objects Leave Area, Object Stops in Area, Direction Violated, Tamper Detection					

\*Analog camera and other camera module options are available upon request.

\*Thermal camera options are available for G model. Please contact us for the details

## Outline Dimensions (mm)

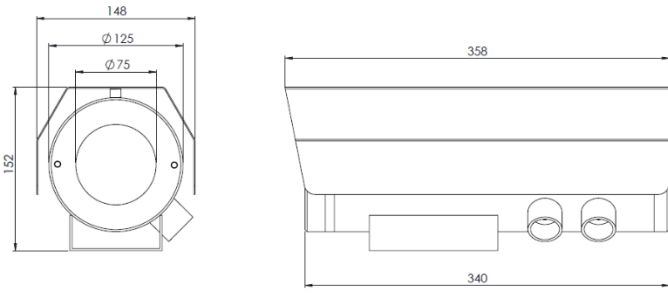

SX1CH Outline Dimensions

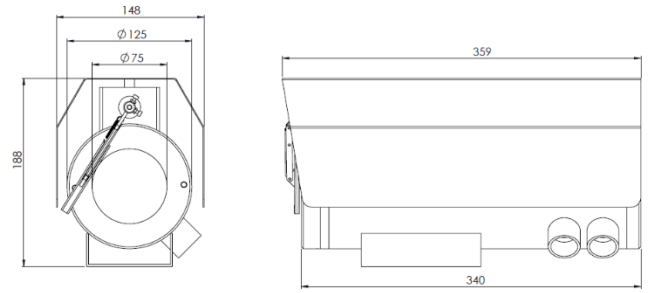

SX1CH-W Outline Dimensions

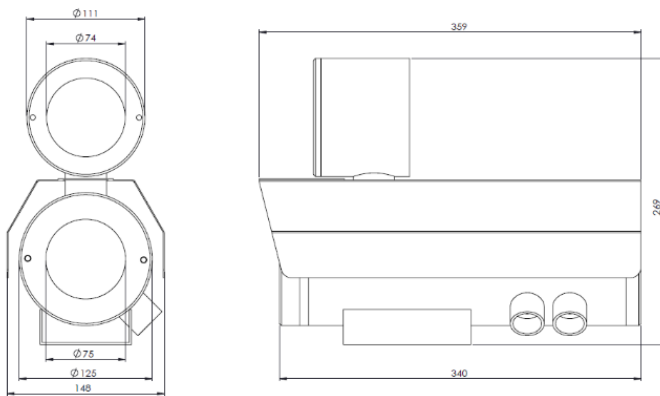

SX1CH-LED Outline Dimensions

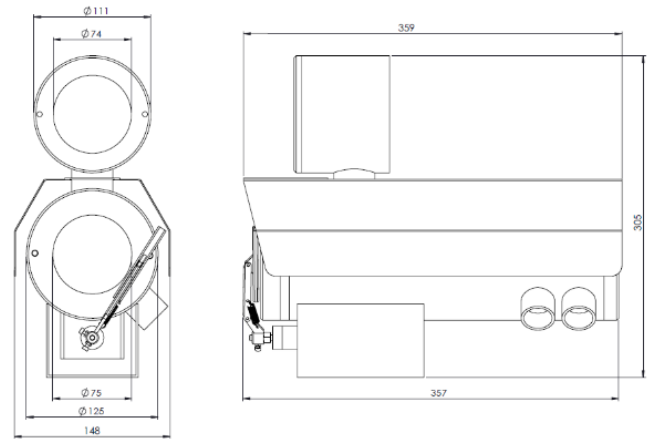

SX1CH-LEDW Outline Dimensions

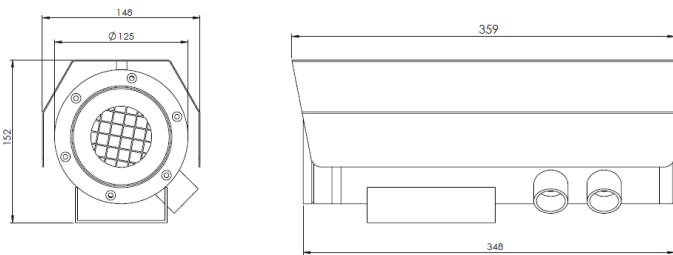

SX1CH-G Outline Dimensions



SX1CH-GL Outline Dimensions

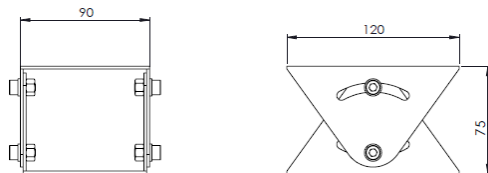

SJ-SX1CH - Swivel Joints Outline Dimensions

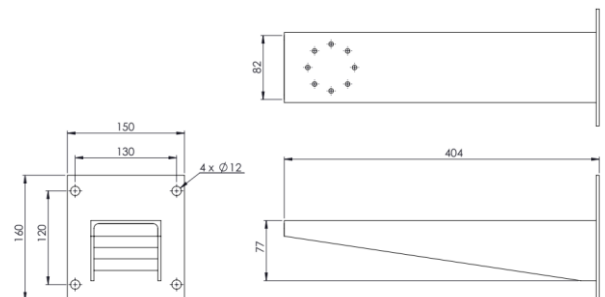

WB-SX1CH - Wall Bracket Outline Dimensions

## Model & Ordering Code

SX1CH - X - X - X

### Built-in Fiber Optic Module Options

Blank : No additional option  
 SM : Single Mode  
 MM : Multi Mode

### Camera Module Options

22x4K : 4K, 22x Zoom, IP  
 33x3M : 3MP, 33x Zoom, IP  
 5X5M : 5MP, 5x Zoom, IP  
 5X8M : 8MP, 5x Zoom, IP  
 18x2M : 2MP, 18x Zoom, IP with Self-learning Video Analytics  
 2M : 2MP, IP with Self-learning Video Analytics  
 4M (9) : 4MP (3.3-9mm), IP with Self-learning Video Analytics  
 4M (22) : 4MP (9-22mm), IP with Self-learning Video Analytics  
 6M : 6MP, IP with Self-learning Video Analytics  
 8M : 8MP, IP with Self-learning Video Analytics

### Additional Options

Blank : No additional option  
 W : Fitted with wiper mechanism  
 LED : With LED Illuminator  
 LEDW : With LED Illuminator and Wiper  
 G : With Germanium Window and Front Guard  
 GL : Large Diameter (143 mm) with Germanium Window and Front Guard

## Standard Accessories

SCH-SX1CH : Sunshield for Camera Housing (for SX1 series without LED illuminator)  
 SCH-SX1CH-LED : Sunshield for Camera Housing with LED illuminator (for SX1CH-LED and SX1CH-LEDW)  
 SJ-SX1CH : Swivel Joints

## Optional Accessories

WB-SX1CH : Wall Bracket