

SS1CH-5x8M Series

Stainless Steel Weatherproof Fixed Camera Housing

Integrated with 8MP [4K] 5x Optical Zoom Ventionex VX2-B8Y Analytics Camera Module



SS1CH

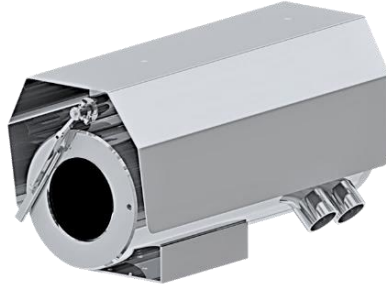

SS1CH-W



SS1CH-LEDW

Main Features



Marine grade
AISI316L Stainless
Steel material



Operating
Temperature -40°C to
60°C



IP 66 / 68



Vandal-proof IK10
ratings



Motorized 2.7 -
13.5mm



Advanced VCA -
Detection and
classification of
specific target types
(people or vehicle)



Option for IEEE
802.3at PoE+



Options for LED
illuminator available

Technical Data

General	
Ingress Protection	IP 66 / 68
Operating Temperature	-40°C to 60°C
Relative Humidity	≤95%
Mechanical	
Body Material	AISI316L Stainless Steel
Sight Glass Material	Window with hardened mineral clear tempered glass
	Window with Germanium glass (for SS1CH-G and SS1CH-GL models)
Overall Dimension (WxHxD)	<i>Please refer to overall dimension drawings of each model.</i>
Internal Usable Size for Camera Module	Ø105 x 250 mm
Cable Entry	2 x M25
Weight	Approximate 20KG
Electrical	
Operating Voltage	AC110-240V (0.5A - 1.10A), 50/60Hz Optional: IEEE 802.3at PoE+
Power Consumption	Max 110W (110V), Max 120W (240V)
Thermostatically Controlled Heater	T°C on: <10°C, T°C off: >10°C
Optional	
Wiper Mechanism	Available for SS1CH-W and SS1CH-LEDW model
LED Illumination	Up to 200 meters (Available for SS1CH-LED and SS1CH-LEDW model)
Accessories	
Standard	Sunshield, Swivel Joints
Optional	Wall Bracket

IP Camera/Lens

Camera	
Image Sensor	1/2.8" CMOS
Signal System	PAL/NTSC
Min. Illumination	Color: 0.003Lux@ (F1.6, ACG ON)
	B/W: 0 Lux with IR
Shutter Time	1s to 1/100000 s
Lens	Motorized 2.7 - 13.5mm, Angle of View: 102.7° ~ 29°
Lens Mount	φ14
Day& Night	Dual IR Cut Filter with Auto Switch
Wide Dynamic Range	120 dB
Image	
Max. Image Resolution	HxV = 3864x2180, 8MP [4K]
Mainstream	PAL: 20fps (3840×2160, 3072x2048), 25fps (2560×1440, 2304×1296, 1920×1080, 1280×720)
	NTSC: 20fps (3840×2160, 3072x2048), 30fps (2560×1440, 2304×1296, 1920×1080, 1280×720)
Substream	PAL: 25fps (704×576, 704×288, 640×480, 352×288)
	NTSC: 30fps (704×480, 704×240, 640×480, 352×240)
3rd Stream	PAL: 25fps (1280×720, 704×576, 704×288, 640×360, 352×288)
	NTSC: 30fps (1280×720, 704×480, 704×240, 640×360, 352×240)
Image Settings	Saturation, brightness, contrast, sharpness, adjustable by web browser
Image Enhancement	BLC/3D DNR/HLC/Corridor Format
Smart Defog	Yes
ROI	Support 8 fixed region of coding
Privacy Mask	Yes, 8 regions
Picture Overlay	Yes
OSD	16×16, 24×24, 32×32, 48×48, 64×64, 96×96, adaptable size, Letters Such as Week, Date, Time, Total 5 Regions
Compression Standard	
Video Compression	S+265/H.265/H.264/M-JPEG
Video Bit Rate	32Kbps~16Mbps
Network	
Protocols	TCP/IP, ICMP, HTTP, HTTPS, DHCP, DNS, DDNS, MULTICAST, UPnP, FTP, IPV4, NTP, RTSP, SMTP, IGMP, QoS, PPPoE
Remote Connection	≤7
System Compatibility	ONVIF (Profile S/T), P2P
Interface	
On-board Storage	MicroSD Card Slot, up to 512GB
Advanced	
Advanced Video Analytics	<p>Tripwire, Double Tripwire, Perimeter, Running, Heatmap, Loitering, Object Abandoned, Missing Object, Parking, Crowd</p> <p>*Support detection and classification of specific target types (people or vehicle) to remove false alarm caused by animals, leaves etc.</p>

*Analog camera and other camera module options are available upon request.

*Thermal camera options are available for G model. Please contact us for the details

Outline Dimensions (mm)

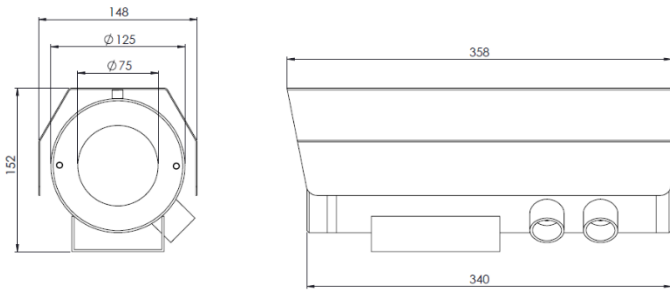

SS1CH Outline Dimensions

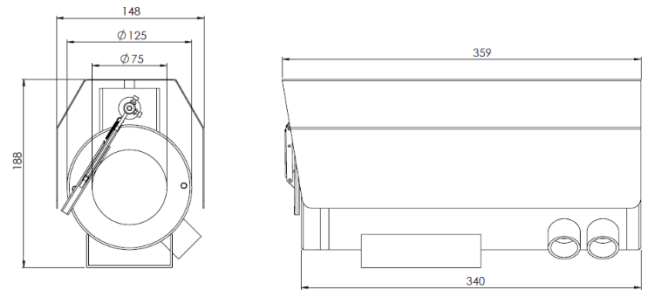

SS1CH-W Outline Dimensions

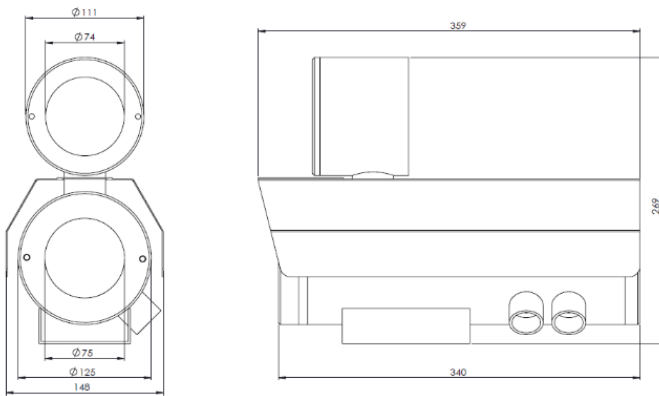

SS1CH-LED Outline Dimensions

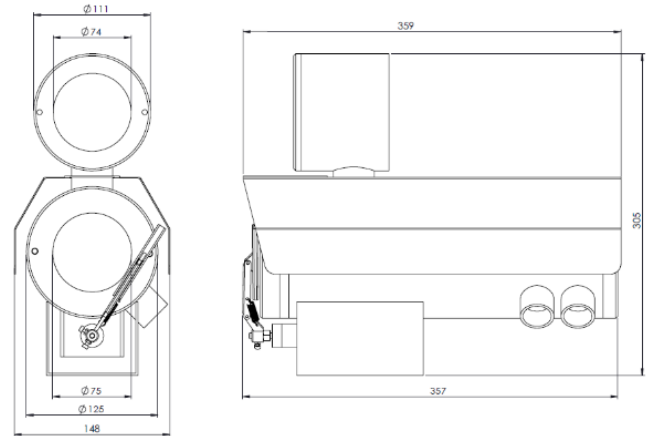

SS1CH-LEDW Outline Dimensions

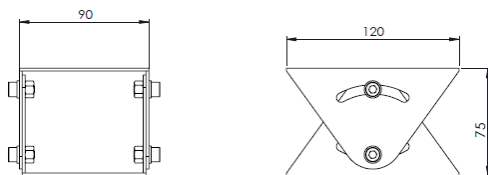

SJ-SS1CH - Swivel Joints Outline Dimensions

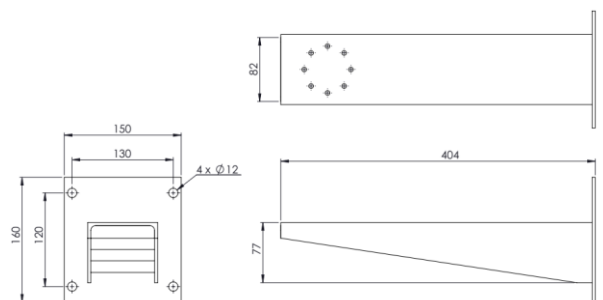

WB-SS1CH - Wall Bracket Outline Dimensions

SS1CH - X - 5x8M - X

POE Options

Blank : No additional option
POE : POE+

Additional Options

Blank : No additional option
W : Fitted with wiper mechanism
LED : With LED Illuminator
LEDW : With LED Illuminator and Wiper

Standard Accessories

SCH-SS1CH : Sunshield for Camera Housing (for SS1 series without LED illuminator)
SCH-SS1CH-LED : Sunshield for Camera Housing with LED illuminator (for SS1CH-LED and SS1CH-LEDW)
SJ-SS1CH : Swivel Joints

Optional Accessories

WB-SS1CH : Wall Bracket